

A710/F730/3800  
点型红外火焰探测器  
快速安装及接线说明

非防爆型红外火焰探测器  
产品型号: A710/F730/3800

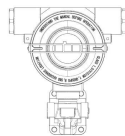

1 安装 HOW TO INSTALL



壁挂式  
默认安装



吸顶式  
默认安装

2 开盖 OPEN SAFETY COVER

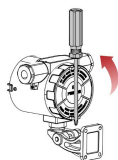

1 拧开背部保护盖

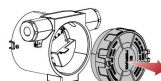

2 拿出保护盖



3 拧开接头

3 接线 WIRING

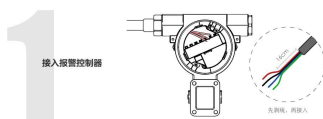

接入报警控制器

电流环接线

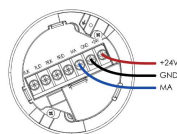

继电器接线

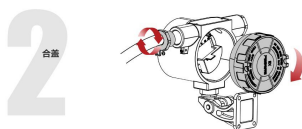
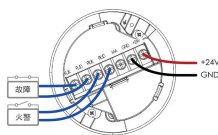

合盖

4 通电 STARTOVER

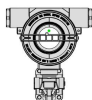

状态1

监视状态  
指示灯为绿色闪烁

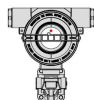

状态2

报警状态  
指示灯为黄色常亮

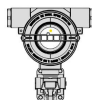

状态3

故障状态  
指示灯为黄色闪烁

注意：探测器安装前应仔细阅读产品说明书，并确认探测器与探测区域相匹配。探测器应安装在探测区域中心位置，且探测器与探测区域中心位置的距离应符合产品说明书的要求。探测器应安装在探测区域中心位置，且探测器与探测区域中心位置的距离应符合产品说明书的要求。







D系列气体检测仪  
点型可燃气体探测器  
快速安装及接线说明



本产品符合下列标准：  
GB 15323-2003 可燃气体探测器 第1部分：点型可燃气体探测器  
GB 15323-2003 可燃气体探测器 第2部分：点型可燃气体探测器

1 安装 HOW TO INSTALL



螺丝式  
Screw-in



推插式  
Push-in



插槽式  
Plug-in

2 开盖 OPEN SAFETY COVER

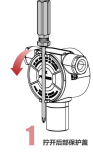

1 拧开顶部保护盖

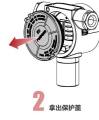

2 拿出保护盖



3 拧开接头

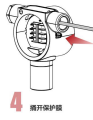

4 撬开保护盖

3 接线 WIRING

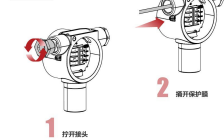
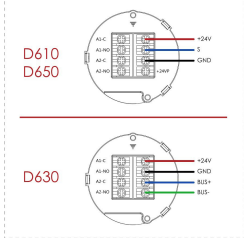

1 拧开接头

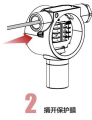

2 撬开保护盖

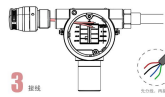

3 接线

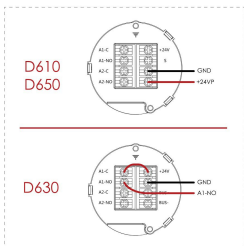

4 通电 STARTOVER



状态1  
开机通电状态

指示灯常亮，报警声



状态2  
报警状态

指示灯“闪烁”，报警声，报警声持续至报警解除为止，报警解除后报警声“短促”报警灯持续亮起。



**KF715UV**  
点型紫外火焰探测器  
快速安装及接线说明



本产品为消防工程产品，  
严禁私自拆卸及改装。

**1 安装 HOW TO INSTALL**



壁挂式  
默认安装

**2 开盖 OPEN SAFETY COVER**

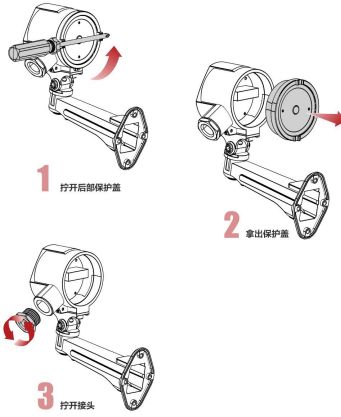

**3 接线 WIRING**



接入报警控制器

先剥线，再压入。

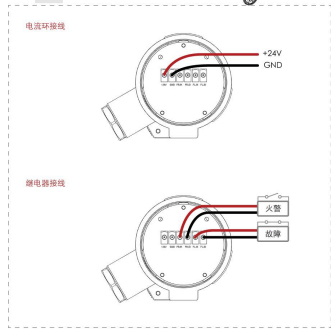

电源环接线

报警电路接线

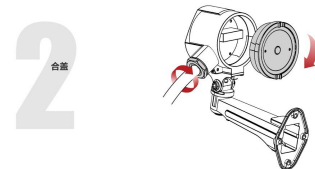

合盖

**4 通电 START OVER**



**状态1**  
监视状态  
指示灯为绿色闪烁



**状态2**  
报警状态  
指示灯为红色常亮



**状态3**  
故障状态  
指示灯为黄色闪烁

注意：本产品为消防工程产品，严禁私自拆卸及改装。如出现报警灯不亮或报警灯常亮等情况，请及时联系消防工程商或生产厂家。本产品为消防工程产品，严禁私自拆卸及改装。

**M650**  
可燃气体报警控制器

快速安装及操作指南



**1 安装 HOW TO INSTALL**

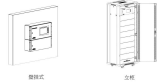

**2 开盖 OPEN SAFETY COVER**



**3 接线 WIRING**

⚠ 带电操作

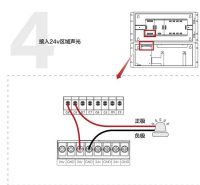
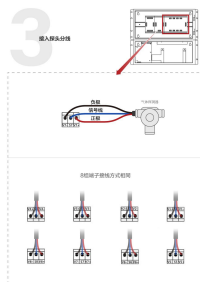
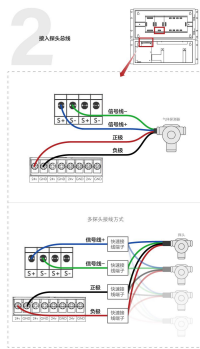
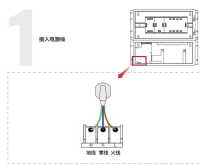
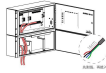

**4 合盖 STARTOVER**



**4 通电 STARTOVER**

